

# UFB1020

Banco CRAM, fabricado en polietileno de diferentes colores con protección UV, medidas: 2000x500x490 mm.

Revision: 01 - 01/02/2021

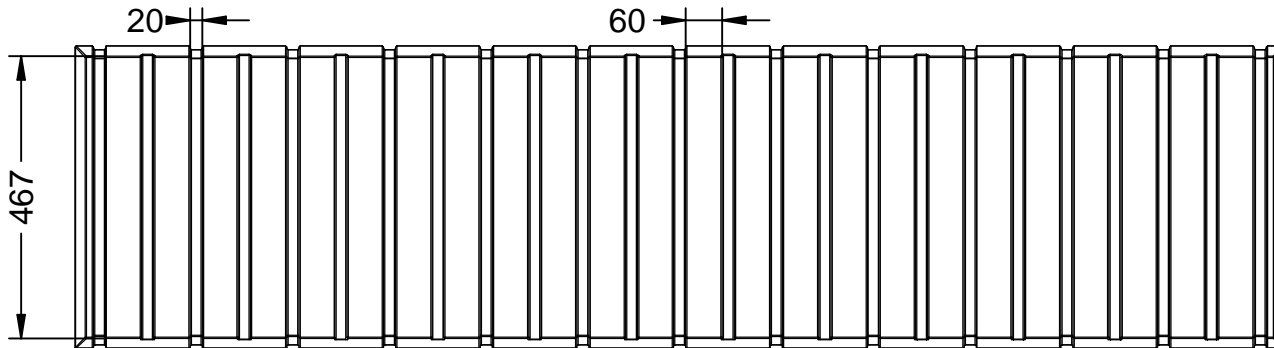
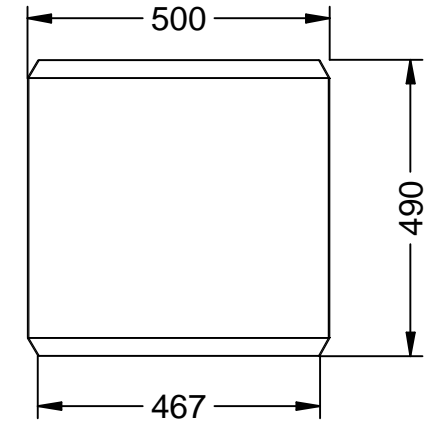
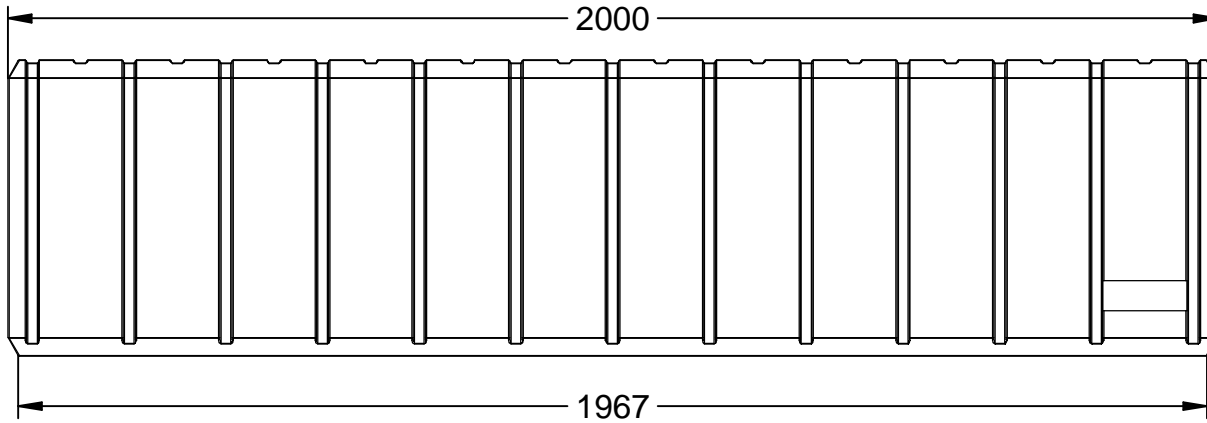

Color blanco



Color gris



Color arena



Disponible en varios colores

## **UFB1020**

Banco CRAM, fabricado en polietileno de diferentes colores con protección UV, medidas: 2000x500x490 mm.

Revision: 01 - 01/02/2021



Disponible en varios colores

Color arena (Referencia UFB1020-ARE)



Color blanco (Referencia UFB1020-BLA)



Color gris (Referencia UFB1020-GRI)



## UFB1020

Banco CRAM, fabricado en polietileno de diferentes colores con protección UV, medidas: 2000x500x490 mm.

Revision: 01 - 01/02/2021



**-ES-** 

Descripción: Banco CRAM, fabricado en polietileno, tiene un % de plástico reciclado procedente de la recogida selectiva de residuos, con protección UV.

Material: Polietileno de media densidad ( MDPE).

Embalaje: Paletizado y plastificado.

Medidas: 2000x500x490 mm.

Peso: 29 Kg.  
Disponible en varios colores ( Blanco, gris y color arena).

**-EN-** 

Description: CRAM model bench, made of polyethylene, has a % of recycled plastic from selective collection waste, with UV protection.

Material: Medium density polyethylene (MDPE).

Packaging: Palletized and plasticized.

Measurements: 2000x500x490 mm.

Weight: 29 Kg.  
Available in several colors (white, gray and sand color).

**-PT-** 

Descrição: Banco CRAM, fabricado em polietileno, possui um % de plástico reciclado da coleta seletiva resíduos, com proteção UV.

Material: Polietileno de média densidade (MDPE).

Embalagem: Paletizada e plastificada.

Medidas: 2000x500x490 milímetros.

Peso: 29kg.  
Disponível em várias cores (branco, cinza e cor areia).

**-CA-** 

Descripció: Banc CRAM, fabricat en polietilè, té un % de plàstic reciclat procedent de la recollida selectiva de residus, amb protecció UV.

Material: Polietilè de mitjana densitat ( MDPE).

Embalatge: Paletitzat i plastificat.

Mides: 2000x500x490 mm.

Pes: 29 Kg.  
Disponible en diversos colors ( Blanc, gris i color sorra).

**-FR-** 

Description: Le banc CRAM, en polyéthylène, a un % de plastique recyclé issu de la collecte sélective déchets, avec protection UV.

Matière: Polyéthylène moyenne densité (MDPE).

Conditionnement: Palettisé et plastifié.

Dimensions: 2000x500x490 mm.

Poids: 29 Kg.  
Disponible en plusieurs coloris (blanc, gris et couleur sable).

## UFB1020

Banco CRAM, fabricado en polietileno de diferentes colores con protección UV, medidas: 2000x500x490 mm.

Revision: 01 - 01/02/2021



### - Gama de Bancos CRAM de polietileno -

UFB1020-ARE ( Color arena)



- UFB1021-ARE ( Color arena)



UFB102145-ARE ( Color arena)

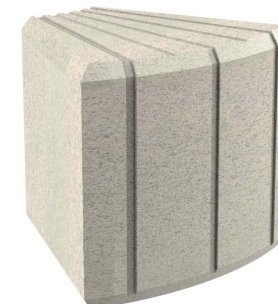

UFB1020-BLA ( Color blanco)



UFB1021-BLA ( Color blanco)



UFB102145-BLA ( Color blanco)



UFB1020-PLAST-GRI ( Color gris)



UFB1021-GRI ( Color gris)



UFB102145-PLAST-GRI ( Color gris)





## UFB1020

Banco CRAM, fabricado en polietileno de diferentes colores con protección UV, medidas: 2000x500x490 mm.

Revision: 01 - 01/02/2021



### - Conjuntos del Banco y Jardinera CRAM -

Banco UFB1020 x2 + UFB102145 x2 +UFB1021  
- Color Arena, gris y blanco -

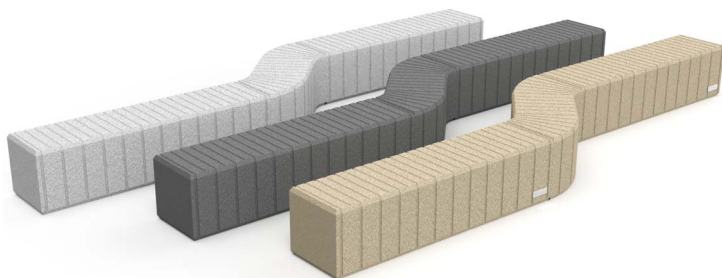

Banco UFB102145 x10  
- Color Blanco -

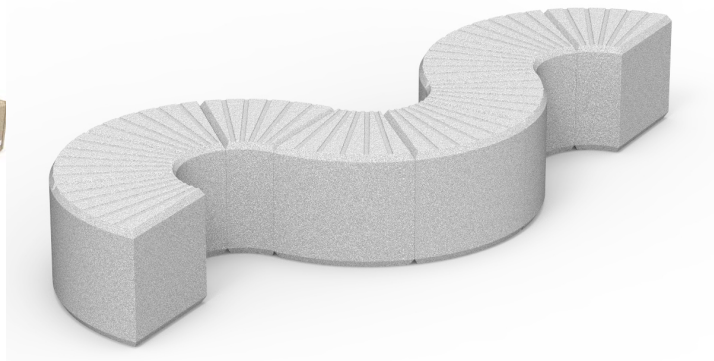

Banco UFB1020 + Jardinera UFG1020  
- Color Arena -

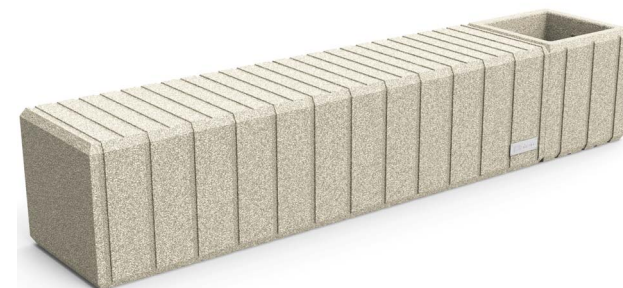
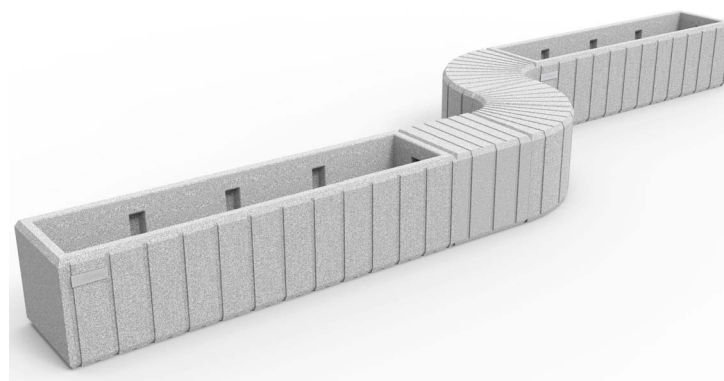
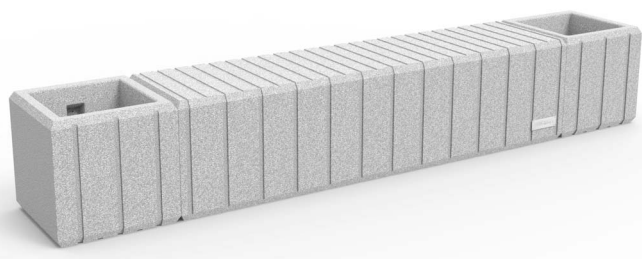
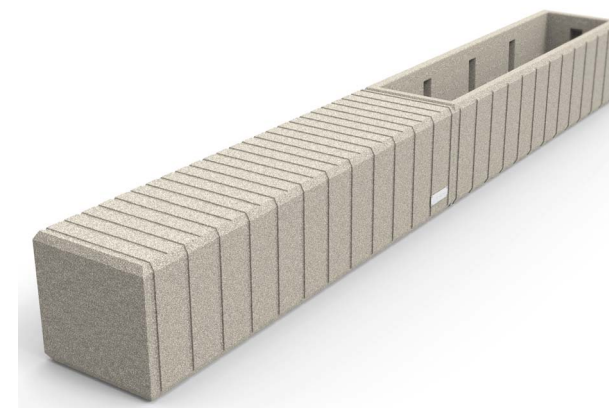

Banco UFB1020 + Jardinera UFG1021 x2  
- Color Blanco -

Jardinera UFG1020 x2 + Banco UFB1021 x1  
+ Banco UFB102145 x4  
- Color Blanco -

Banco UFB1020 + Jardinera UFG1021  
- Color Arena -

## UFB1020

Banco CRAM, fabricado en polietileno de diferentes colores con protección UV, medidas: 2000x500x490 mm.

Revision: 01 - 01/02/2021



### UFB1020 - En el entorno -

